

## Catalogue

### Snubber is used for IGBT high frequency protection

|   |    |
|---|----|
| DTM Square shell welding piece 700-3000Vdc..... | 04 |
| DTM Square shell pad three-level 700-1700Vdc.   | 11 |
| DTS Axial lead 700-3000Vdc.....                 | 12 |
| DTC Square shell pin 700-3000Vdc.....           | 16 |

### DC-Link DC filter for DC chain support

|   |           |
|---|-----------|
| DHA Square shell pin 700-1100Vdc.....                                 | 22        |
| DHB High ripple isolation 400,800,1000Vdc .....                       | <b>60</b> |
| DCG Square aluminum or stainless steel housing 2000-4000Vdc.....      | 27        |
| DHF Round plastic shell 500-2200Vdc.....                              | 29        |
| DHE Round plastic shell 900-4000Vdc.....                              | 31        |
| DHD Circular aluminum shell with high energy density 700-1200Vdc..... | 35        |
| DHC Square aluminum & plastic shell 450-800Vdc.....                   | 38        |

### AC For AC filtering

|   |    |
|---|----|
| DAF Square aluminum shell three-phase 400-1000Vac.....                    | 39 |
| DMP Round aluminum shell three-phase 400-1400Vac.....                     | 41 |
| DMB Round aluminum shell three-phase explosion-proof 450-1400Vac.....     | 43 |
| DRP Circular aluminum shell single phase 300-1400Vac.....                 | 45 |
| DRG Single phase explosion-proof circular aluminum shell 300-1400Vac..... | 47 |
| DTG Square shell pin 250-500Vac.....                                      | 50 |
| DRB Square shell pin 330-850Vdc.....                                      | 54 |

### High frequency high current high ripple resonance

|   |    |
|---|----|
| DGR High frequency resonance 2000-4000Vdc.....    | 58 |
| DHB High ripple isolation 400,800,1000Vdc.....    | 60 |
| DGT High current GTO protection 2400-8000Vdc..... | 63 |
| DTH Thyristor GTO protection 4000-20000Vdc.....   | 65 |
| DCH High frequency resonance 500-3000Vac.....     | 67 |
| DCD High current resonance 400-700Vac.....        | 68 |

### High voltage application

|   |           |
|---|-----------|
| DMS Axial lead 4000-15000Vdc.....               | 69        |
| DTH Thyristor GTO protection 4000-20000Vdc..... | <b>65</b> |

### Technical terms and definitions..... 01

|  |  |
|--|--|
| Capacity current voltage test voltage  |  |
| Equivalent series resistance self induced resonant frequency dielectric loss factor power loss |  |
| Thermal resistance climate category altitude   |  |
| Humidity level air gap creepage distance life  |  |

### Product installation and operation guide ..... 02

|  |  |
|--|--|
| Welding condition assembly position terminal block |  |
|--|--|

### End of product life and waste disposal ..... 03

|                                    |    |
|------------------------------------|----|
| Transportation and packaging ..... | 03 |
|------------------------------------|----|

### Product application description ..... 03

|                                       |  |
|---------------------------------------|--|
| DC-Link . AC application service life |  |
|---------------------------------------|--|

matters needing attention Third cover



At any time, we may change the contents of this manual. For more information, please refer to our website or consult the sales staff.  
<http://www.dawncap.cn> [www.dawncapacitors.com](http://www.dawncapacitors.com)

E-mail:dawncapacitor@163.com

## 1. Technical terms and definitions

### 1.1 rated capacitance $C_n$

The test condition is  $20 \pm 5$  ° C, 100Hz, and the measured capacitor capacity.

### 1.2 Rated voltage $U_n$

The design rating of capacitor refers to the maximum or peak value of non reverse voltage waveform.

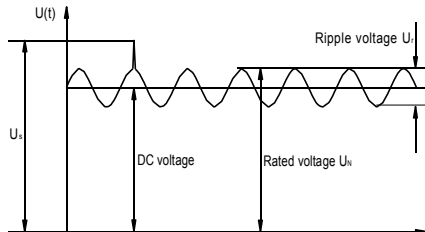

### 1.3 Unrepeatable peak (aperiodic surge) voltage $U_s$

For the voltage exceeding the rated value caused by equipment switch or line fault, the duration of each time shall not exceed 50dms,

and the maximum number of times allowed is 1000.

### 1.4 ripple voltage $U_r$

Peak to peak of AC component of unidirectional rectified voltage

### 1.5 Rated AC voltage $U_r$ DMS

Root mean square of the maximum sine wave AC voltage in continuous operation.

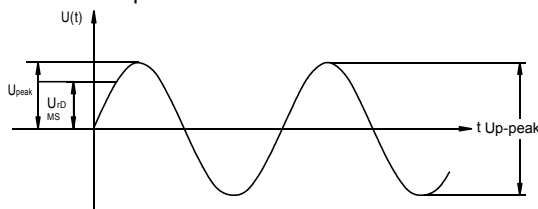

### 1.6 A.C Peak voltage $U_{peak}$

Allowable A.C peak voltage in continuous operation

### 1.7 DU/DT

The rise or fall time of the maximum voltage is generally described as the value that the capacitor can withstand the rise or fall of voltage per microsecond

### 1.8 Maximum non repeatable voltage rise (du/dt) $s$

Transient and non repeatable voltage rise peak due to fault.

### 1.9 Test voltage between electrodes $U_t-t$

Routine test items under room temperature before delivery. At the user's site, it is allowed to conduct another test according to 80% of the test voltage indicated in the product specification.

### 1.10 test voltage $U_t-c$ between electrode and shell

For the routine test items at room temperature, the withstand voltage between the electrode and the shell shall be tested after the electrode is short circuited. Repeated tests are allowed at the user's site.

### 1.11 peak current $I_{peak}$

Maximum allowable repeatable current amplitude during continuous operation.  $I_{peak} = C_n \times (du/dt)$

### 1.12 maximum current I<sub>max</sub>

The maximum effective current during continuous operation. The maximum current given in the data sheet depends on the maximum power loss or the current limit of the capacitor terminal.

Relationship between I<sub>rDMS</sub> and ambient temperature:

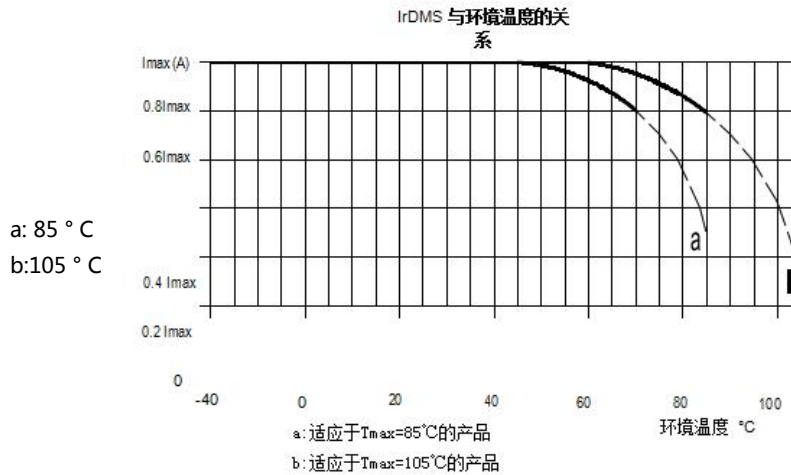

### 1.13 non repetitive peak current (surge) I<sub>s</sub>

The maximum current that occurs temporarily and unrepeatedly due to a fault. The duration of each time shall not exceed 50dms, and the maximum number of occurrences allowed is 1000.  $I_s = C_n \times (du / dt) s$

### 1.14 equivalent series resistance ESR

The equivalent resistance value of all resistance related factors in the capacitor. Circuit power loss used to calculate current.

### 1.15 self inductance L<sub>S</sub>

The inductance of a capacitor due to its own structure.

### 1.16 insulation resistance I<sub>R</sub>

It is usually expressed by the charging time constant R · C: under the ambient temperature of 20 ± 5 ° C and the voltage of 100VDC, the reading 1 minute after the capacitor is fully charged, measure the leakage current and calculate the IR It is usually expressed by charging time constant R.C. the unit of R.C is s:

$$s = M\Omega \times \mu F$$

### 1.17 resonance frequency f<sub>r</sub>

Capacitance and self inductance will form a series resonant circuit. Outside this resonant frequency, if the inductive reactance of the LC line is dominant, the capacitor will present the characteristics of an inductance

$$f_r = \frac{1}{2\pi\sqrt{C_n \times L_s}}$$

### 1.18 Dielectric loss factor Tanδ<sub>0</sub>

Fixed loss factor of capacitor dielectric material at rated frequency.

### 1.19 loss factor Tan δ

$$\tan \delta = \text{two} \times \pi \times f \times C_n \times \text{ESR}$$

### 1.20 thermal resistance R<sub>TH</sub>

It refers to the rising value of the hot spot temperature of the capacitor corresponding to the loss of the capacitor.

### 1.21 maximum power loss P<sub>max</sub>

$$P_{max} = \frac{T_{hs} - T_e}{R_{th}}$$

### 1.22 ambient temperature t<sub>e</sub>

The air temperature around the capacitor, the test point is 10 cm away from the vertical height of the capacitor shell. Hot spot temperature t<sub>hs</sub> The highest temperature inside the capacitor

**1.23 Hot spot temperature  $t_{hs}$** 

The highest temperature inside the capacitor.

**1.24 minimum climate temperature  $T_{min}$** 

Minimum allowable temperature of capacitor in use

**1.25 maximum climate temperature  $T_{max}$** 

The maximum allowable temperature when the capacitor is used, that is, the maximum temperature of the shell.

**1.26 rated energy storage  $W_N$** 

Energy storage capacity of capacitor during charging at rated voltage

$$W_n = 1/2 \times C_n \times (U_n)^2$$

**1.27 air gap  $L$** 

The shortest distance between the conductive parts of the electrode or between the electrode and the housing.

**1.28 creepage distance  $K$** 

The shortest distance between the conductive parts of the electrode or the insulating surface between the electrode and the shell.

**1.29 altitude**

The maximum allowable altitude is 2000 meters. With the decrease of atmospheric pressure, arc discharge is more likely to occur between electrodes. When used at high altitude, the capacitor is not easy to dissipate heat, which will lead to increased loss and failure.

**1.30 storage temperature**

Allowable storage temperature range of capacitor.

**1.31 life expectancy  $L_e$** 

The expected life of capacitor depends on the internal temperature and dielectric field strength. Relationship between life expectancy and voltage

$$L_e = L_n \times (U_n/U_w)^7$$

$L_e$  = life expectancy at operating voltage (H)  $L_n$  = life expectancy at rated voltage (H)  $U_n$  = rated voltage (V)

$U_w$  = working voltage (V)

Relationship between life expectancy and temperature

$$L_e = L_{T0} \times 2^{(T_0 - T_{hs})/11}$$

$L_e$  = life expectancy at actual hot spot temperature (H)  $L_{T0}$  = hot spot temperature 70 ° Life expectancy at C (H)  $T_0$  = hot spot temperature 70 ° C ( ° C)

$T_{hs}$  = hot spot temperature in actual operation ( ° C)

**2. Installation and operation guide****2.1 overvoltage circuit breaker**

When using explosion-proof capacitors, it must be ensured that:

the connecting wire must have a certain elasticity to prevent the connecting wire from pulling and losing the explosion-proof function during explosion-proof action. an expansion space  $\geq 12\text{mm}$  shall be reserved above the electrode of the capacitor.

**2.2 installation position**

In addition to the specially specified series, for example, DAF / DMB / DRG series can only be installed vertically, that is, the electrode is above, and other capacitors can adopt different installation directions. However, pay attention to the following situations: aluminum shell capacitors and rectangular metal shell capacitors with voltage higher than 3600v must be installed horizontally. for capacitors with high voltage or circular steel shell, horizontal installation is allowed, but the manufacturer should be consulted in advance.

**2.3 assembly**

If the vibration stress does not exceed 5g, the bolts at the bottom of aluminum shell capacitor with diameter 60 mm and height 160 mm can be used for fixing. For larger diameter and vibration stress greater than 5g, the capacitor needs to be fixed with clamp ring.

Bolt installation data:

| Bolt diameter | Bolt length | Maximum torque |
|---------------|-------------|----------------|
| M8            | 10mm        | 4.5N.m         |
| M10           | 12mm        | 6N.m           |
| M12           | 16mm        | 8N.m           |

### 2.4 installing terminals

The tightening torque of bolts and nuts for installing terminals can be referred to a separate data sheet. These torques cannot be used on plastic parts.

| Bolt diameter | Maximum torque |
|---------------|----------------|
| M5            | 2.5N.m         |
| M6            | 4.5N.m         |
| M8            | 8.5N.m         |

| Screw diameter | Maximum torque |
|----------------|----------------|
| M8             | 8.5N.m         |
| M10            | 12N.m          |
| M12            | 15N.m          |

#### 2.4.1 the maximum cross section of connecting wire shall be in accordance with VDE / din

Flexible wires should be used for terminals with ceramics as insulators, so as to avoid mechanical stress on ceramics.

The wiring outside the capacitor needs to consider that the heat cannot be transmitted to other components, and also consider keeping the heat away from the terminal of the capacitor.

### 2.5 grounding

According to VDE 0100, both bottom bolts and iron hoops can be used for grounding. Single pole and fully insulated capacitors can not be grounded. When the metal clamp is used for grounding, the paint on the surface of the clamp needs to be removed.

### 2.6 safety protection measures

When using, pay attention to the self charging phenomenon, and the capacitor contains high electric energy, and observe appropriate safety protection measures.

### 2.7 welding conditions of axial and box capacitors on PCB

In order to control the temperature inside the capacitor, the setting of welding temperature shall not exceed the following limit: soldering bath temperature  $260 \pm 5$  °C. For box capacitors with a foot distance greater than 10mm, the welding time is 4S. When welding, it must be ensured that the capacitor will not be damaged due to overheating: if the cross section of the conductor is greater than 1.5 mm<sup>2</sup>, the welding method shall not be adopted, but the fastening connection method shall be adopted.

do not weld in the heat concentrated part.

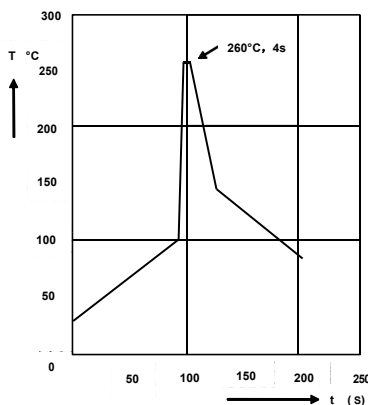

|   |   |
|---|---|
| Tin dipping depth   | The horizontal plane of capacitor body or substrate is upward 2.0 +0/-0.5mm                               |
| Protective plate  | Heat absorption plate, (1.5 ± 0.5) mm thick, It is placed between the capacitor body and the tin material |
| Evaluation criteria:<br>Visual inspection<br>C/C <sub>0</sub><br>Tanδ | No visible damage<br>2% for DTC/DTG/DRB/DTG<br>5% for DTC/DTG/DRB/DTG                                     |

### 3. End of product life and waste disposal

Dawncap capacitor materials strictly comply with national regulations:

chemical prohibition regulations

CFC halogen prohibition regulations

Our products do not contain PCB, so there is no need to deal with scrapped products according to the special management regulations on waste disposal.

We need to be responsible for the environment, so we hope users should be careful when dealing with waste products. In any case, we hope users will consult the waste disposal department for relevant regulations.

### 4. Transportation and packaging

In terms of product packaging, dawncap naturally supports the needs of environmental protection.

use environmentally friendly materials and try to use product packaging.

pallets shall be used as far as possible, and the pallets shall be fixed with environmental friendly PE or PP plastic belts.

cardboard is preferred for the isolation layer of pallet and packing box.

## 5. Product application description

#### 5.1dc Link Application

The rated voltage of the capacitor must be equal to or greater than the sum of the applied voltage and the line ripple voltage:  $UN \geq UDC + ur / 2$

Select the corresponding capacitance CN and rated voltage UN according to the parameters in the data sheet; At the same time, the maximum effective current that the capacitor can withstand during long-term operation needs to be verified. Maximum effective

IMAX depends on the terminals of the capacitor and the values specified in the data sheet.

The surge voltage in the following range will not have a significant impact on the shortening of the expected life of the capacitor:

| Repetitive surge voltage | Maximum duration              |
|--------------------------|-------------------------------|
| 1.1 × Un                 | Working time totle 30%        |
| 1.15 × Un                | 30 min/d 5                    |
| 1.2 × Un                 | min/d 1                       |
| 1.3 × Un                 | min/d                         |
| 1.5 × Un                 | 100 DMS , No more than 1000 次 |

#### 5.2 Ac application

The rated voltage of the capacitor must be equal to or greater than the maximum of upeak1 and upeak2. Select the corresponding capacitance CN and rated voltage UN according to the parameters in the data sheet; At the same time, the maximum effective current that the capacitor can withstand during long-term operation needs to be verified. The maximum effective IMAX depends on the terminals of the capacitor and the values specified in the data sheet.

#### 5.3 Ac filtering application

The standard for selecting the rated voltage UN of AC filter capacitor is not the effective voltage urdms, but the peak voltage formed by the superposition of various harmonics, which is calculated by instrument test or according to the harmonic data provided. In any case, the rated voltage of the capacitor must be greater than the peak voltage in the line.

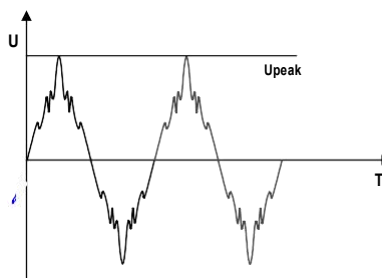

## 5.4 service life

The working life of the capacitor depends on the temperature and dielectric field strength inside the capacitor under working conditions. The average life of the capacitor design is 100000 hours. (allowable failure rate  $\leq 150\text{ppm}$ ). These values are related to the hot spot temperature indicated in the selection table.

The following icons illustrate the relationship between life, temperature and operating voltage:

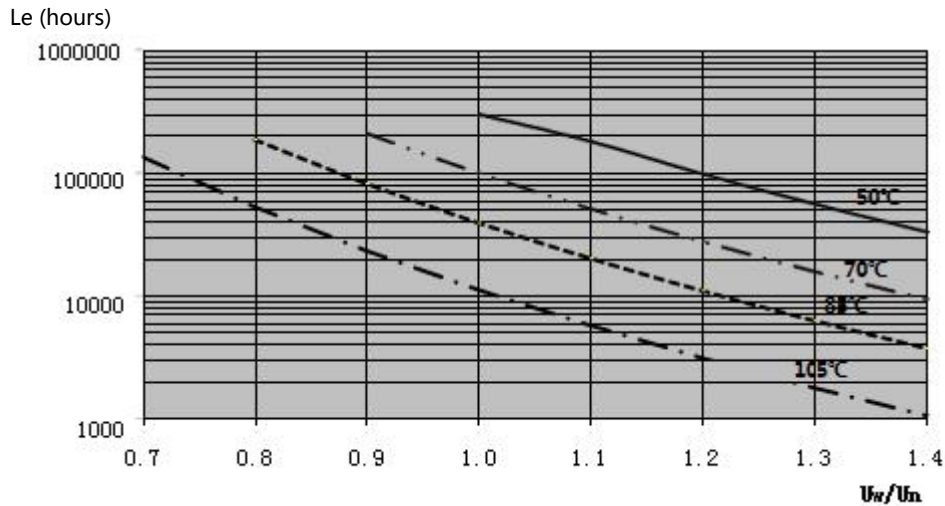

## 5.5 Life Declaration and invalidation

There may be unreasonable assumptions, and users will form a wrong idea about the service life: as long as the rated service temperature and working voltage are reduced, the service life of the capacitor will be one million hours or more. Please note that the statement about the life of the capacitor is purely theoretical.

## 5.6 failure modes

Plastic film capacitors have two typical failure modes: open circuit or short circuit (or high resistance short circuit). In addition, capacitance drift, unstable working temperature, high loss or low insulation resistance will lead to capacitor failure. All failures are caused by dielectric degradation caused by exceeding the limits of electrical, mechanical and environmental factors during operation.

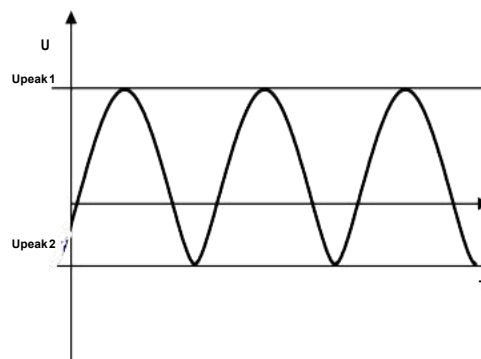

### GENERAL TECHNICAL CHARACTERISTICS

- Dielectric : Polypropylene film
- Construction : Dry construction, filled by solid resin  
Non-inductive type
- Case : Dry construction
- Leads: Tinneaded insert M6 or M8 filde with resin

### ELECTRICAL CHARACTERISTICS

- Working teGperature : - 40 to + 85 °C
- Capacitance : 0.00504 to 4μF
- Rated Voltage : 1200~8000Vac
- Tolerance : ± 5%, ± 10%
- Dissipation factor: Geasured at 1000±20 Hz AND 25±5°C.  
When  $C_r \leq 1.0\mu F$ ,  $4 \times 10^{-4}$ ;  
When  $C_r > 1.0\mu F$ ,  $6 \times 10^{-4}$
- Life expectancy: 10,000 hours at  $U_n$  and 70°C  
(Hotspot temperature)



### TEST GETHODS AND PERFORGANCES

- Dielectric strength: 1.5UN (DC) applied for 10s at 25±5°C  
(1 minute for type test)

**Test voltage terminal to case :3000Vac,(10s 85KHz 20± 5°C)**

- Insulation resistance : 5000s but need not exceed 30GΩ  
(typical value), after 1 minute of electrification at 100Vdc (25±5°C)

应用电路图:

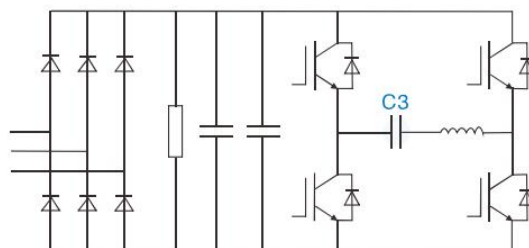
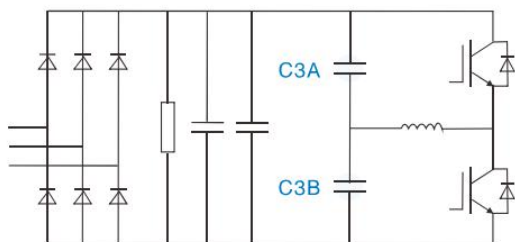

### 外型及尺寸/Outline drawing

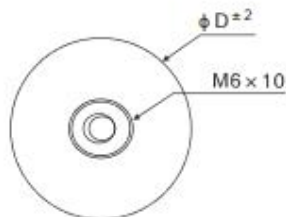
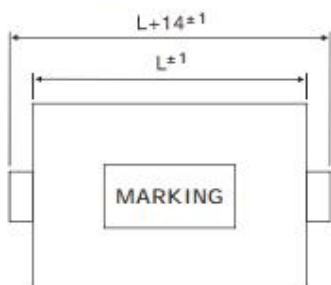

Outline drawing A...



## 外型及尺寸/Outline drawing

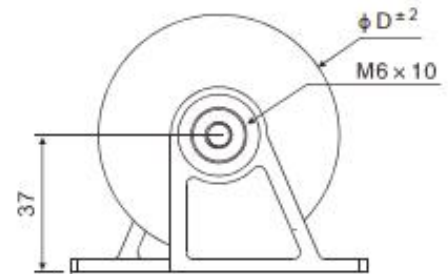
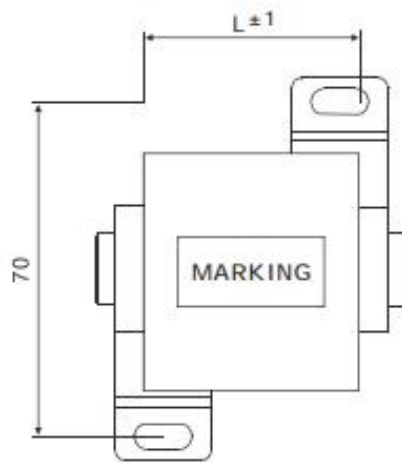

Outline drawing B...

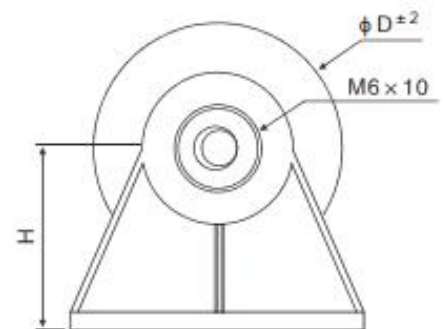
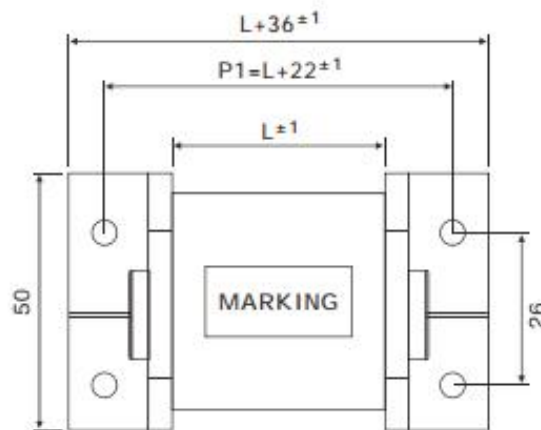

Outline drawing C...



### Electrical specifications, ordering codes

| Part Number        | CAP<br>μF | Dimension (mm) |    |     |        | du/dt<br>v/μs | ESR@<br>85kHz | I <sub>rms</sub> @25C<br>@85kHz |
|--------------------|-----------|----------------|----|-----|--------|---------------|---------------|---------------------------------|
|                    |           | L              | D  | T   | Output |               |               |                                 |
| Un 3000Vac (M6&M8) |           |                |    |     |        |               |               |                                 |
| DER3000K102-**-M6  | 0.001     | 55             | 30 | 5.0 | M6     | 3500          | 2.0           | 20                              |
| DER3000K332-**-M6  | 0.0033    | 55             | 30 | 5.0 | M6     | 3500          | 2.0           | 20                              |
| DER3000K472-**-M6  | 0.0047    | 55             | 32 | 5.0 | M6     | 3500          | 2.0           | 20                              |
| DER3000K103-**-M6  | 0.01      | 55             | 32 | 5.0 | M6     | 3500          | 2.0           | 30                              |
| DER3000K153-**-M6  | 0.015     | 55             | 42 | 5.0 | M6     | 3500          | 2.0           | 35                              |
| DER3000K223-**-M6  | 0.022     | 55             | 45 | 5.0 | M6     | 3500          | 2.0           | 40                              |
| DER3000K333-**-M6  | 0.033     | 55             | 55 | 5.0 | M6     | 3500          | 2.0           | 40                              |
| DER3000K473-**-M6  | 0.047     | 55             | 63 | 5.0 | M6     | 3500          | 2.0           | 45                              |
| DER3000K683-**-M6  | 0.068     | 55             | 65 | 5.0 | M6     | 3500          | 2.0           | 45                              |
| DER3000K104-**-M6  | 0.10      | 55             | 72 | 5.0 | M6     | 3500          | 2.0           | 50                              |
| UN 6000VAC         |           |                |    |     |        |               |               |                                 |
| DTR6000K102-**-M6  | 0.001     | 77             | 30 | 5.0 | M6     | 3500          | 2.0           | 30                              |
| DTR6000K222-**-M6  | 0.0022    | 77             | 30 | 5.0 | M6     | 3500          | 2.0           | 30                              |
| DTR6000K332-**-M6  | 0.0033    | 77             | 30 | 5.0 | M6     | 3500          | 2.0           | 40                              |
| DTR6000K472-**-M6  | 0.0047    | 77             | 30 | 5.0 | M6     | 3500          | 2.0           | 40                              |
| DTR6000K602-**-M6  | 0.006     | 77             | 30 | 5.0 | M6     | 3500          | 2.0           | 40                              |
| DTR6000K103-**-M6  | 0.01      | 77             | 50 | 5.0 | M6     | 3500          | 2.0           | 40                              |
| DTR6000K203-**-M6  | 0.02      | 77             | 50 | 5.0 | M6     | 3500          | 2.0           | 40                              |
| UN 8000VAC         |           |                |    |     |        |               |               |                                 |
| DTR8000K102-**-M6  | 0.001     | 120            | 30 | 5.0 | M6     | 3500          | 2.0           | 30                              |
| DTR8000K222-**-M6  | 0.0022    | 120            | 30 | 5.0 | M6     | 3500          | 2.0           | 30                              |
| DTR8000K332-**-M6  | 0.0033    | 120            | 50 | 5.0 | M6     | 3500          | 2.0           | 40                              |
| DTR8000K472-**-M6  | 0.0047    | 120            | 50 | 5.0 | M6     | 3500          | 2.0           | 40                              |
| DTR8000K602-**-M6  | 0.006     | 120            | 50 | 5.0 | M6     | 3500          | 2.0           | 40                              |
| DTR8000K103-**-M6  | 0.01      | 120            | 50 | 5.0 | M6     | 3500          | 2.0           | 40                              |
| DTR8000K203-**-M6  | 0.02      | 120            | 50 | 5.0 | M6     | 3500          | 2.0           | 40                              |

## 预期寿命曲线 Lifetime expectancy

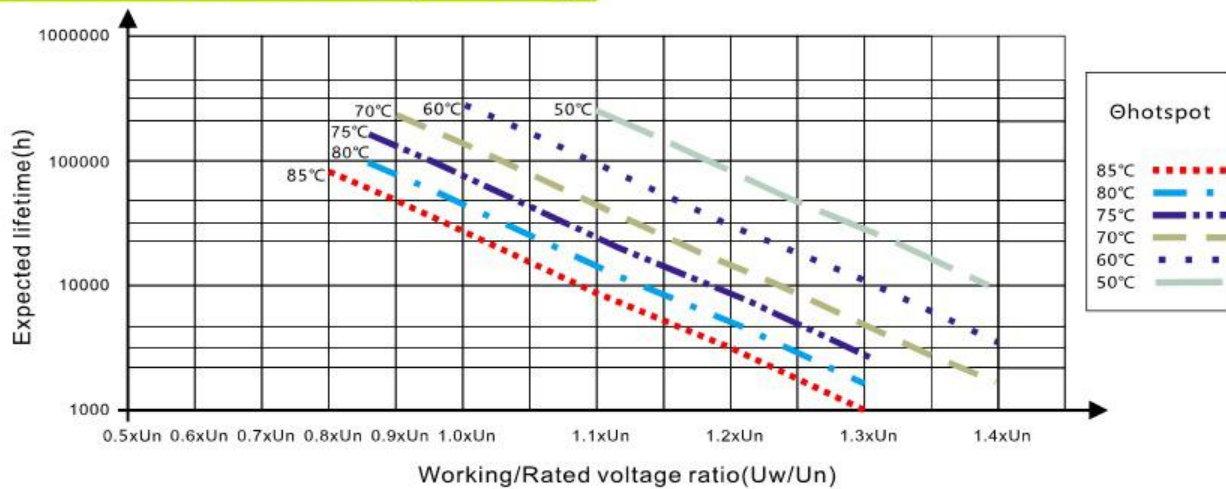

How to Order:

DER-2000 - 104 K M8

