

Catalogue

Snubber is used for IGBT high frequency protection

DTM Square shell welding piece 700-3000Vdc.....	04
DTM Square shell pad three-level 700-1700Vdc.	11
DTS Axial lead 700-3000Vdc.....	12
DTC Square shell pin 700-3000Vdc.....	16

DC-Link DC filter for DC chain support

DHA Square shell pin 700-1100Vdc.....	22
DHB High ripple isolation 400,800,1000Vdc	60
DCG Square aluminum or stainless steel housing 2000-4000Vdc.....	27
DHF Round plastic shell 500-2200Vdc.....	29
DHE Round plastic shell 900-4000Vdc.....	31
DHD Circular aluminum shell with high energy density 700-1200Vdc.....	35
DHC Square aluminum & plastic shell 450-800Vdc.....	38

AC For AC filtering

DAF Square aluminum shell three-phase 400-1000Vac.....	39
DMP Round aluminum shell three-phase 400-1400Vac.....	41
DMB Round aluminum shell three-phase explosion-proof 450-1400Vac.....	43
DRP Circular aluminum shell single phase 300-1400Vac.....	45
DRG Single phase explosion-proof circular aluminum shell 300-1400Vac.....	47
DTG Square shell pin 250-500Vac.....	50
DRB Square shell pin 330-850Vdc.....	54

High frequency high current high ripple resonance

DGR High frequency resonance 2000-4000Vdc.....	58
DHB High ripple isolation 400,800,1000Vdc.....	60
DGT High current GTO protection 2400-8000Vdc.....	63
DTH Thyristor GTO protection 4000-20000Vdc.....	65
DCH High frequency resonance 500-3000Vac.....	67
DCD High current resonance 400-700Vac.....	68

High voltage application

DMS Axial lead 4000-15000Vdc.....	69
DTH Thyristor GTO protection 4000-20000Vdc.....	65

Technical terms and definitions..... 01

Capacity current voltage test voltage	
Equivalent series resistance self induced resonant frequency dielectric loss factor power loss	
Thermal resistance climate category altitude	
Humidity level air gap creepage distance life	

Product installation and operation guide 02

Welding condition assembly position terminal block	
--	--

End of product life and waste disposal 03

Transportation and packaging	03
------------------------------------	----

Product application description 03

DC-Link . AC application service life	
---------------------------------------	--

matters needing attention Third cover



At any time, we may change the contents of this manual. For more information, please refer to our website or consult the sales staff.
<http://www.dawncap.cn> www.dawncapacitors.com

E-mail:dawncapacitor@163.com

1. Technical terms and definitions

1.1 rated capacitance C_n

The test condition is 20 ± 5 ° C, 100Hz, and the measured capacitor capacity.

1.2 Rated voltage U_n

The design rating of capacitor refers to the maximum or peak value of non reverse voltage waveform.

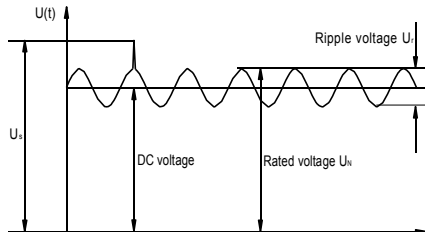

1.3 Unrepeatable peak (aperiodic surge) voltage U_s

For the voltage exceeding the rated value caused by equipment switch or line fault, the duration of each time shall not exceed 50dms,

and the maximum number of times allowed is 1000.

1.4 ripple voltage U_r

Peak to peak of AC component of unidirectional rectified voltage

1.5 Rated AC voltage U_r DMS

Root mean square of the maximum sine wave AC voltage in continuous operation.

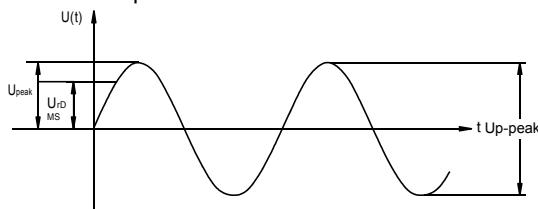

1.6 A.C Peak voltage U_{peak}

Allowable A.C peak voltage in continuous operation

1.7 DU/DT

The rise or fall time of the maximum voltage is generally described as the value that the capacitor can withstand the rise or fall of voltage per microsecond

1.8 Maximum non repeatable voltage rise (du/dt)s

Transient and non repeatable voltage rise peak due to fault.

1.9 Test voltage between electrodes U_t-t

Routine test items under room temperature before delivery. At the user's site, it is allowed to conduct another test according to 80% of the test voltage indicated in the product specification.

1.10 test voltage U_t-c between electrode and shell

For the routine test items at room temperature, the withstand voltage between the electrode and the shell shall be tested after the electrode is short circuited. Repeated tests are allowed at the user's site.

1.11 peak current I_{peak}

Maximum allowable repeatable current amplitude during continuous operation. $I_{peak} = C_n \times (du/dt)$

1.12 maximum current I_{max}

The maximum effective current during continuous operation. The maximum current given in the data sheet depends on the maximum power loss or the current limit of the capacitor terminal.

Relationship between I_{rDMS} and ambient temperature:

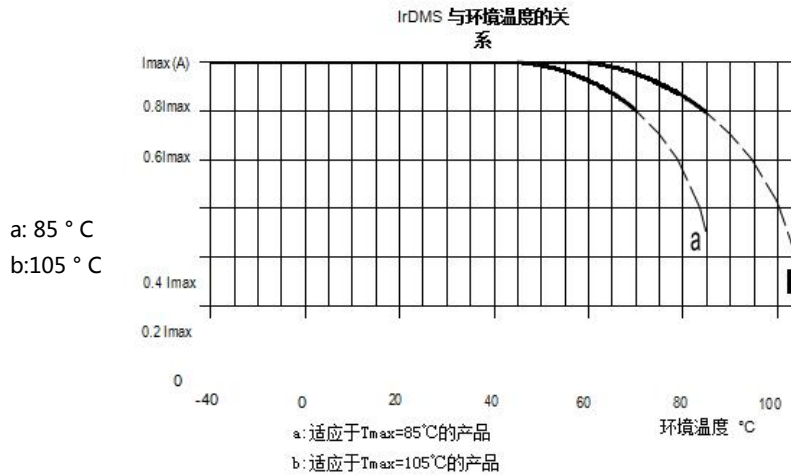

1.13 non repetitive peak current (surge) I_s

The maximum current that occurs temporarily and unrepeatedly due to a fault. The duration of each time shall not exceed 50dms, and the maximum number of occurrences allowed is 1000. $I_s = C_n \times (du / dt) s$

1.14 equivalent series resistance ESR

The equivalent resistance value of all resistance related factors in the capacitor. Circuit power loss used to calculate current.

1.15 self inductance L_S

The inductance of a capacitor due to its own structure.

1.16 insulation resistance I_R

It is usually expressed by the charging time constant R · C: under the ambient temperature of 20 ± 5 ° C and the voltage of 100VDC, the reading 1 minute after the capacitor is fully charged, measure the leakage current and calculate the IR It is usually expressed by charging time constant R.C. the unit of R.C is s:

$$s = M\Omega \times \mu F$$

1.17 resonance frequency f_r

Capacitance and self inductance will form a series resonant circuit. Outside this resonant frequency, if the inductive reactance of the LC line is dominant, the capacitor will present the characteristics of an inductance

$$f_r = \frac{1}{2\pi\sqrt{C_n \times L_s}}$$

1.18 Dielectric loss factor Tanδ₀

Fixed loss factor of capacitor dielectric material at rated frequency.

1.19 loss factor Tan δ

$$\tan \delta = 2\pi \times f \times C_n \times ESR$$

1.20 thermal resistance R_{TH}

It refers to the rising value of the hot spot temperature of the capacitor corresponding to the loss of the capacitor.

1.21 maximum power loss P_{max}

$$P_{max} = \frac{T_{hs} - T_e}{R_{th}}$$

1.22 ambient temperature t_e

The air temperature around the capacitor, the test point is 10 cm away from the vertical height of the capacitor shell. Hot spot temperature t_{hs} The highest temperature inside the capacitor

1.23 Hot spot temperature t_{hs}

The highest temperature inside the capacitor.

1.24 minimum climate temperature T_{min}

Minimum allowable temperature of capacitor in use

1.25 maximum climate temperature T_{max}

The maximum allowable temperature when the capacitor is used, that is, the maximum temperature of the shell.

1.26 rated energy storage W_N

Energy storage capacity of capacitor during charging at rated voltage

$$W_n = 1/2 \times C_n \times (U_n)^2$$

1.27 air gap L

The shortest distance between the conductive parts of the electrode or between the electrode and the housing.

1.28 creepage distance K

The shortest distance between the conductive parts of the electrode or the insulating surface between the electrode and the shell.

1.29 altitude

The maximum allowable altitude is 2000 meters. With the decrease of atmospheric pressure, arc discharge is more likely to occur between electrodes. When used at high altitude, the capacitor is not easy to dissipate heat, which will lead to increased loss and failure.

1.30 storage temperature

Allowable storage temperature range of capacitor.

1.31 life expectancy L_e

The expected life of capacitor depends on the internal temperature and dielectric field strength. Relationship between life expectancy and voltage

$$L_e = L_n \times (U_n/U_w)^7$$

L_e = life expectancy at operating voltage (H) L_n = life expectancy at rated voltage (H) U_n = rated voltage (V)

U_w = working voltage (V)

Relationship between life expectancy and temperature

$$L_e = L_{T0} \times 2^{(T_0 - T_{hs})/11}$$

L_e = life expectancy at actual hot spot temperature (H) L_{T0} = hot spot temperature 70 ° Life expectancy at C (H) T_0 = hot spot temperature 70 ° C (° C)

T_{hs} = hot spot temperature in actual operation (° C)

2. Installation and operation guide**2.1 overvoltage circuit breaker**

When using explosion-proof capacitors, it must be ensured that:

the connecting wire must have a certain elasticity to prevent the connecting wire from pulling and losing the explosion-proof function during explosion-proof action. an expansion space $\geq 12\text{mm}$ shall be reserved above the electrode of the capacitor.

2.2 installation position

In addition to the specially specified series, for example, DAF / DMB / DRG series can only be installed vertically, that is, the electrode is above, and other capacitors can adopt different installation directions. However, pay attention to the following situations: aluminum shell capacitors and rectangular metal shell capacitors with voltage higher than 3600v must be installed horizontally. for capacitors with high voltage or circular steel shell, horizontal installation is allowed, but the manufacturer should be consulted in advance.

2.3 assembly

If the vibration stress does not exceed 5g, the bolts at the bottom of aluminum shell capacitor with diameter 60 mm and height 160 mm can be used for fixing. For larger diameter and vibration stress greater than 5g, the capacitor needs to be fixed with clamp ring.

Bolt installation data:

Bolt diameter	Bolt length	Maximum torque
M8	10mm	4.5N.m
M10	12mm	6N.m
M12	16mm	8N.m

2.4 installing terminals

The tightening torque of bolts and nuts for installing terminals can be referred to a separate data sheet. These torques cannot be used on plastic parts.

Bolt diameter	Maximum torque
M5	2.5N.m
M6	4.5N.m
M8	8.5N.m

Screw diameter	Maximum torque
M8	8.5N.m
M10	12N.m
M12	15N.m

2.4.1 the maximum cross section of connecting wire shall be in accordance with VDE / din

Flexible wires should be used for terminals with ceramics as insulators, so as to avoid mechanical stress on ceramics.

The wiring outside the capacitor needs to consider that the heat cannot be transmitted to other components, and also consider keeping the heat away from the terminal of the capacitor.

2.5 grounding

According to VDE 0100, both bottom bolts and iron hoops can be used for grounding. Single pole and fully insulated capacitors can not be grounded. When the metal clamp is used for grounding, the paint on the surface of the clamp needs to be removed.

2.6 safety protection measures

When using, pay attention to the self charging phenomenon, and the capacitor contains high electric energy, and observe appropriate safety protection measures.

2.7 welding conditions of axial and box capacitors on PCB

In order to control the temperature inside the capacitor, the setting of welding temperature shall not exceed the following limit: soldering bath temperature $260 \pm 5^\circ\text{C}$. For box capacitors with a foot distance greater than 10mm, the welding time is 4S. When welding, it must be ensured that the capacitor will not be damaged due to overheating: if the cross section of the conductor is greater than 1.5 mm^2 , the welding method shall not be adopted, but the fastening connection method shall be adopted.

do not weld in the heat concentrated part.

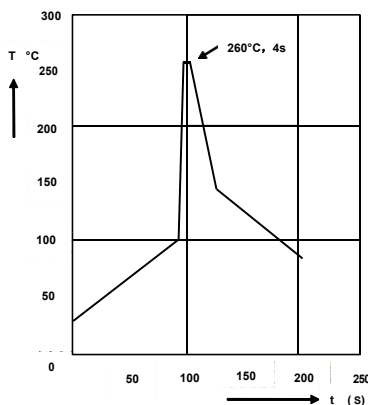

Tin dipping depth	The horizontal plane of capacitor body or substrate is upward $2.0 +0/-0.5\text{mm}$
Protective plate	Heat absorption plate, (1.5 ± 0.5) mm thick, It is placed between the capacitor body and the tin material
Evaluation criteria: Visual inspection C/C ₀ Tanδ	No visible damage 2% for DTC/DTG/DRB/DTG 5% for DTC/DTG/DRB/DTG

3. End of product life and waste disposal

Dawncap capacitor materials strictly comply with national regulations:

chemical prohibition regulations

CFC halogen prohibition regulations

Our products do not contain PCB, so there is no need to deal with scrapped products according to the special management regulations on waste disposal.

We need to be responsible for the environment, so we hope users should be careful when dealing with waste products. In any case, we hope users will consult the waste disposal department for relevant regulations.

4. Transportation and packaging

In terms of product packaging, dawncap naturally supports the needs of environmental protection.

use environmentally friendly materials and try to use product packaging.

pallets shall be used as far as possible, and the pallets shall be fixed with environmental friendly PE or PP plastic belts.

cardboard is preferred for the isolation layer of pallet and packing box.

5. Product application description

5.1dc Link Application

The rated voltage of the capacitor must be equal to or greater than the sum of the applied voltage and the line ripple voltage: $UN \geq UDC + ur / 2$

Select the corresponding capacitance CN and rated voltage UN according to the parameters in the data sheet; At the same time, the maximum effective current that the capacitor can withstand during long-term operation needs to be verified. Maximum effective

IMAX depends on the terminals of the capacitor and the values specified in the data sheet.

The surge voltage in the following range will not have a significant impact on the shortening of the expected life of the capacitor:

Repetitive surge voltage	Maximum duration
1.1 × Un	Working time totle 30%
1.15 × Un	30 min/d 5
1.2 × Un	min/d 1
1.3 × Un	min/d
1.5 × Un	100 DMS , No more than 1000 次

5.2 Ac application

The rated voltage of the capacitor must be equal to or greater than the maximum of upeak1 and upeak2. Select the corresponding capacitance CN and rated voltage UN according to the parameters in the data sheet; At the same time, the maximum effective current that the capacitor can withstand during long-term operation needs to be verified. The maximum effective IMAX depends on the terminals of the capacitor and the values specified in the data sheet.

5.3 Ac filtering application

The standard for selecting the rated voltage UN of AC filter capacitor is not the effective voltage urdms, but the peak voltage formed by the superposition of various harmonics, which is calculated by instrument test or according to the harmonic data provided. In any case, the rated voltage of the capacitor must be greater than the peak voltage in the line.

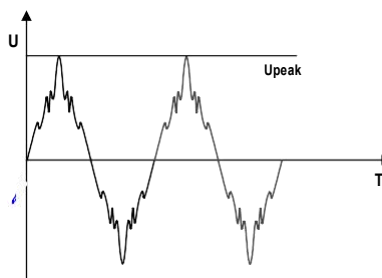

5.4 service life

The working life of the capacitor depends on the temperature and dielectric field strength inside the capacitor under working conditions. The average life of the capacitor design is 100000 hours. (allowable failure rate $\leq 150\text{ppm}$). These values are related to the hot spot temperature indicated in the selection table.

The following icons illustrate the relationship between life, temperature and operating voltage:

Le (hours)

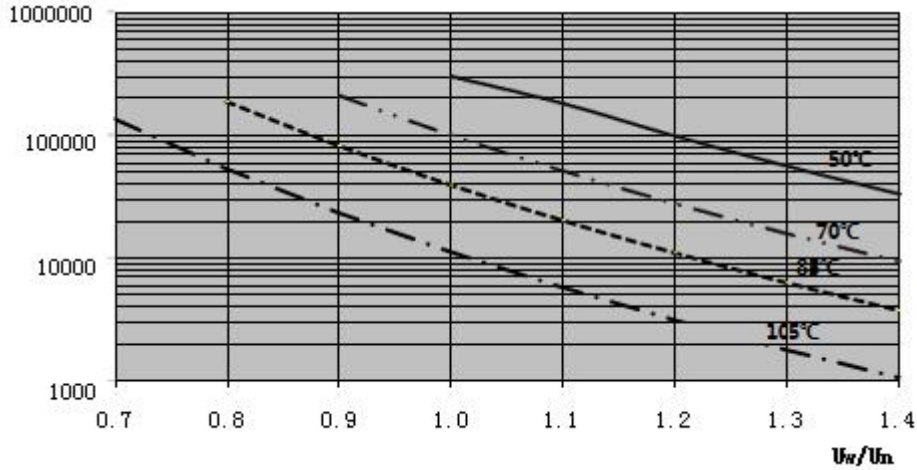

5.5 Life Declaration and invalidation

There may be unreasonable assumptions, and users will form a wrong idea about the service life: as long as the rated service temperature and working voltage are reduced, the service life of the capacitor will be one million hours or more. Please note that the statement about the life of the capacitor is purely theoretical.

5.6 failure modes

Plastic film capacitors have two typical failure modes: open circuit or short circuit (or high resistance short circuit). In addition, capacitance drift, unstable working temperature, high loss or low insulation resistance will lead to capacitor failure. All failures are caused by dielectric degradation caused by exceeding the limits of electrical, mechanical and environmental factors during operation.

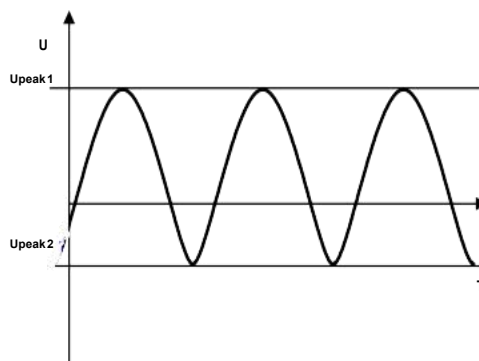

Product features

Reference standard: IEC 61071
 Media: Metallized polypropylene film
 Structure: Dry non inductive structure, polyester tape packaging, resin filling (UL94 V-0)

Electrical characteristics

Operating temperature: - 40 to + 85 ° C
 Capacity range: 0.5 to 12 μ F
 Rated voltage: 400 to 700 VAC
 Capacity deviation: ± 5%, ± 10%
 Loss factor: ≤ 5 × 10⁻⁴ @ 1KHz, 20±5 ° C
 Life expectancy: 100000 hours @ UN, 70 ° C (hot spot temperature)
 Withstand voltage between poles: 1.5UrDMS (AC) @ 10s, 20±5 ° C
 Withstand voltage of polar shell: (1.5upeak + 1000) VAC, minimum 3000VAC (10s, 50Hz)
 Insulation resistance: (IR × Cn) 30000s (no more than 30g Ω, 100VDC (20 ± 5 ° C), 1 minute)

Application

resonance

Septal straight

High current application



M6*8	M8*8
d= 15mm	d= 18mm
4.5 N.m Max	8.5 N.m Max

应用电路图:

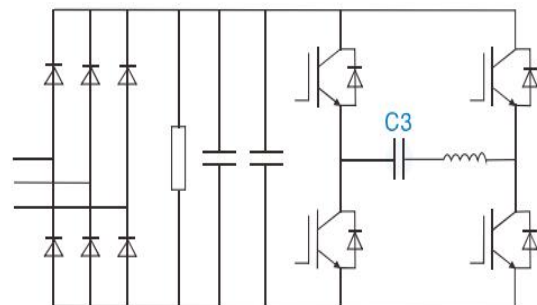
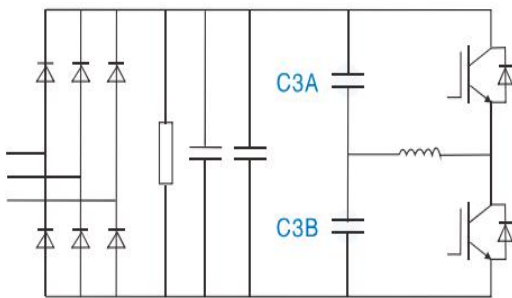

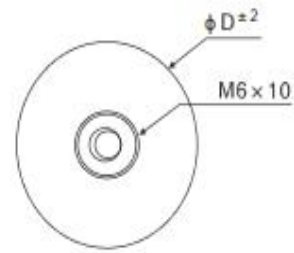
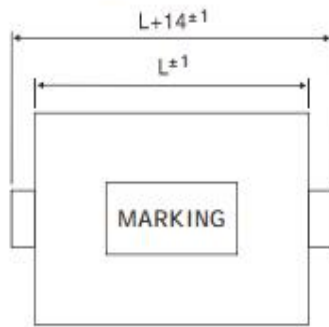

Outline drawing A...

外型及尺寸/Outline drawing

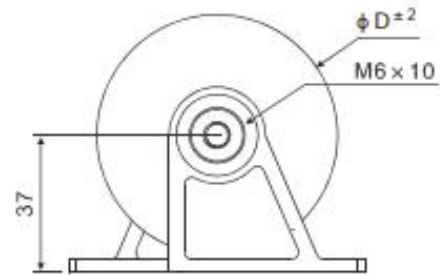
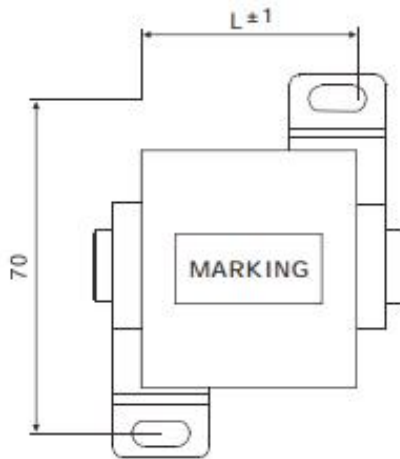

Outline drawing B...

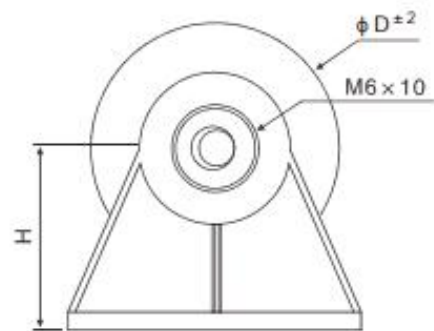
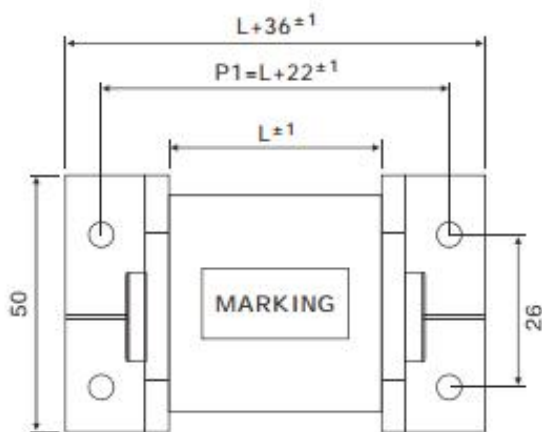

Outline drawing C...

Electrical specifications, ordering codes

Part Number	CAP µF	Dimension (mm)				Output	du/dt v/µs	I _{peak} A	ESR@ 1.0kHz	I _{rms} @25C @10kHz
		L	D	T						
Un1200Vdc Urms 500Vac										
DTR1200K1.0- <i>*#</i>	1	37	35	5.0	M6	1100	1100	2.3	30	
DTR1200K1.5- <i>*#</i>	1.5	37	42	5.0	M6	1100	1650	2.2	35	
DTR1200K2.0- <i>*#</i>	2	37	48	5.0	M6	900	1800	2.1	40	
DTR1200K2.5- <i>*#</i>	2.2	37	50	5.0	M6	900	1980	2.1	43	
DTR1200K3.0- <i>*#</i>	3	37	58	5.0	M6	800	2400	1.8	47	
DTR1200K3.3- <i>*#</i>	3.3	37	61	5.0	M6	800	2640	1.7	50	
DTR1200K4.0- <i>*#</i>	4	37	67	5.0	M6	600	2400	1.6	56	
Un1200Vdc Urms 500Vac										
DTR1200K4.7- <i>*#</i>	4.7	37	73	5.0	M6	600	2820	1.5	62	
DTR1200K5.0- <i>*#</i>	5	37	76	5.5	M6	600	3000	1.4	65	
DTR1200K6.0- <i>*#</i>	6	37	82	5.5	M6	600	3600	1.2	75	
Un2000Vdc Urms 750Vac										
DTR2000K0.22- <i>*#</i>	0.22	37	38	5.0	M6	1500	330	2.8	27	
DTR2000K0.3- <i>*#</i>	0.3	37	38	5.0	M6	1500	450	2.7	30	
DTR2000K0.33- <i>*#</i>	0.33	37	38	5.0	M6	1500	495	2.7	32	
DTR2000K0.4- <i>*#</i>	0.4	37	43	5.0	M6	1500	600	2.7	36	
DTR2000K0.44- <i>*#</i>	0.44	37	45	5.0	M6	1500	660	2.6	38	
DTR2000K0.47- <i>*#</i>	0.47	37	46	5.0	M6	1500	705	2.6	40	
DTR2000K0.60- <i>*#</i>	0.6	37	51	5.0	M6	1500	900	2.5	45	
DTR2000K0.7- <i>*#</i>	0.7	37	55	5.0	M6	1500	1050	2.4	48	
DTR2000K0.9- <i>*#</i>	0.9	37	62	5.0	M6	1100	990	2.3	52	
DTR2000K1.0- <i>*#</i>	1.0	37	65	5.0	M6	1100	1100	2.2	55	
Un3000Vdc Urms 1200Vac										
DTR3000K0.2- <i>*#</i>	0.2	40	43	5.0	M6	1800	360	2.8	32	
DTR3000K0.3- <i>*#</i>	0.3	40	52	5.0	M6	1800	540	2.6	38	
DTR3000K0.4- <i>*#</i>	0.4	40	60	5.0	M6	1800	720	2.5	45	
DTR3000K0.44- <i>*#</i>	0.44	40	62	5.0	M6	1800	792	2.5	48	
DTR3000K0.47- <i>*#</i>	0.47	40	65	5.0	M6	1500	705	2.4	50	
DTR3000K0.6- <i>*#</i>	0.6	40	73	5.0	M6	1500	900	2.2	58	
DTR3000K0.65- <i>*#</i>	0.65	40	76	5.5	M6	1500	975	2.1	60	
DTR3000K0.7- <i>*#</i>	0.7	40	79	5.5	M6	1500	1050	2	65	
Un5000Vdc Urms 2000Vac										
DTR5000K0.04- <i>*#</i>	0.04	54	58	5.0	M6	3000	120	2.2	35	
DTR5000K0.06- <i>*#</i>	0.06	54	66	5.0	M6	3000	180	2.2	45	
DTR5000K0.08- <i>*#</i>	0.08	54	58	5.0	M6	3000	240	2.2	45	
DTR5000K0.12- <i>*#</i>	0.12	54	70	5.0	M6	3000	360	2	50	
DTR5000K0.14- <i>*#</i>	0.14	54	76	5.5	M6	3000	420	1.8	58	
DTR5000K0.2- <i>*#</i>	0.2	54	90	5.5	M8	3000	600	1.6	65	
DTR5000K0.22- <i>*#</i>	0.22	54	94	5.5	M8	3000	660	1.5	70	
Un6000Vdc Urms 3000Vac										
DTR6000K0.01- <i>*#</i>	0.01	55	30	5.0	M6	3500	35	2.0	30	
DTR6000K0.10- <i>*#</i>	0.1	55	38	5.0	M6	3500	350	2.0	40	
DTR6000K0.22- <i>*#</i>	0.22	55	58	5.0	M6	3500	770	2.0	50	
DTR6000K0.33- <i>*#</i>	0.33	55	63	5.0	M6	3500	1155	2.0	60	

Part Number	CAP μF	Dimension (mm)				du/dt v/μs	Ipeak A	ESR@ 1.0kHz	Irms@25C @10kHz
		L	D	T	output				
DTR6000K0.40-*#	0.40	55	70	5.0	M6	3500	1400	2.0	70
DTR6000K0.44-*#	0.44	55	72	5.0	M6	3500	1540	2.0	70
DTR6000K0.47-*#	0.47	55	74	5.0	M6	3500	1645	1.8	75
DTR6000K0.50-*#	0.50	55	77	5.0	M6	3500	1750	1.8	80
DTR6000K0.60-*#	0.60	55	82	5.0	M6	3500	2100	1.8	80
DTR6000K0.68-*#	0.68	55	88	5.0	M6	3500	2380	1.6	80
DTR6000K0.70-*#	0.70	55	90	5.0	M6	3500	2450	1.6	80

Product characteristic Curve:

特性曲线/Characteristic curve

